

CAMPO DE FUTBOL DE BELVIS

santiago de compostela

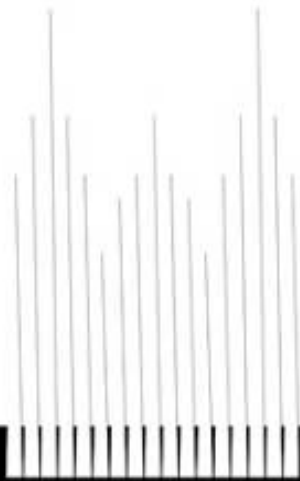

SITUACION

CONCELLO
DE
SANTIAGO



Urbana
Santiago
Norte

TALIESEN ARQUITECTOS, S.L.P.
ARQUITECTURA Y URBANISMO

CAMPO DE FUTBOL DE BELVIS

santiago de compostela



EMPLAZAMIENTO

CONCELLO
DE
SANTIAGO



Urbana
Santiago
Norte

TALIESEN ARQUITECTOS, S.L.P.
ARQUITECTURA Y URBANISMO

CAMPO DE FUTBOL DE BELVIS

santiago de compostela

PLANTA DE ORDENACION

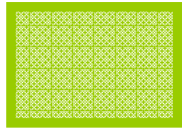

Terreno de juego

Dimensiones 30x50 m

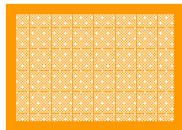

Vestuarios

Sup. Construida 68.67 m²

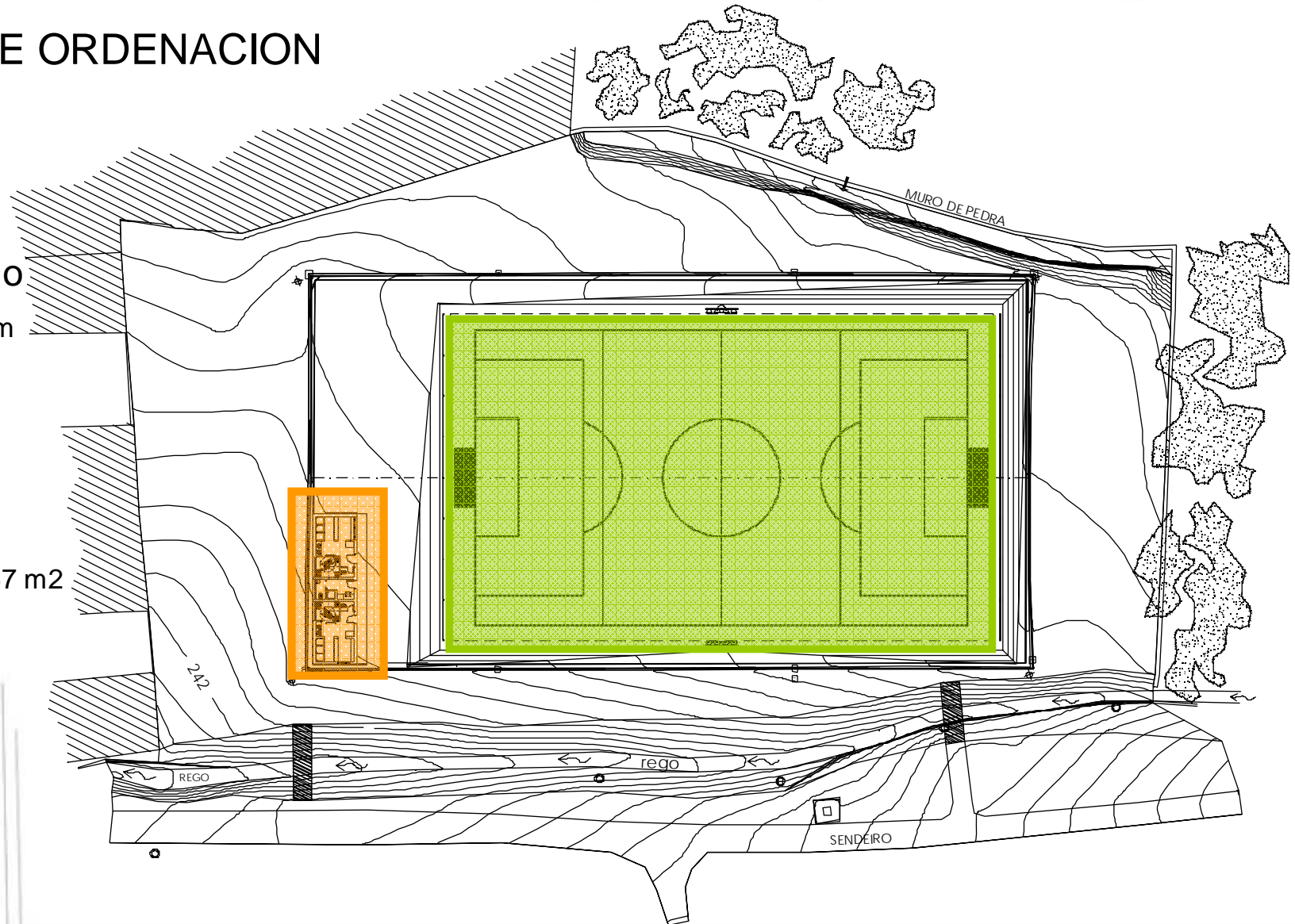

CONCELLO
DE
SANTIAGO



Urbana
Santiago
Norte

TALIESEN ARQUITECTOS, S.L.P.
ARQUITECTURA Y URBANISMO

CAMPO DE FUTBOL DE BELVIS

santiago de compostela

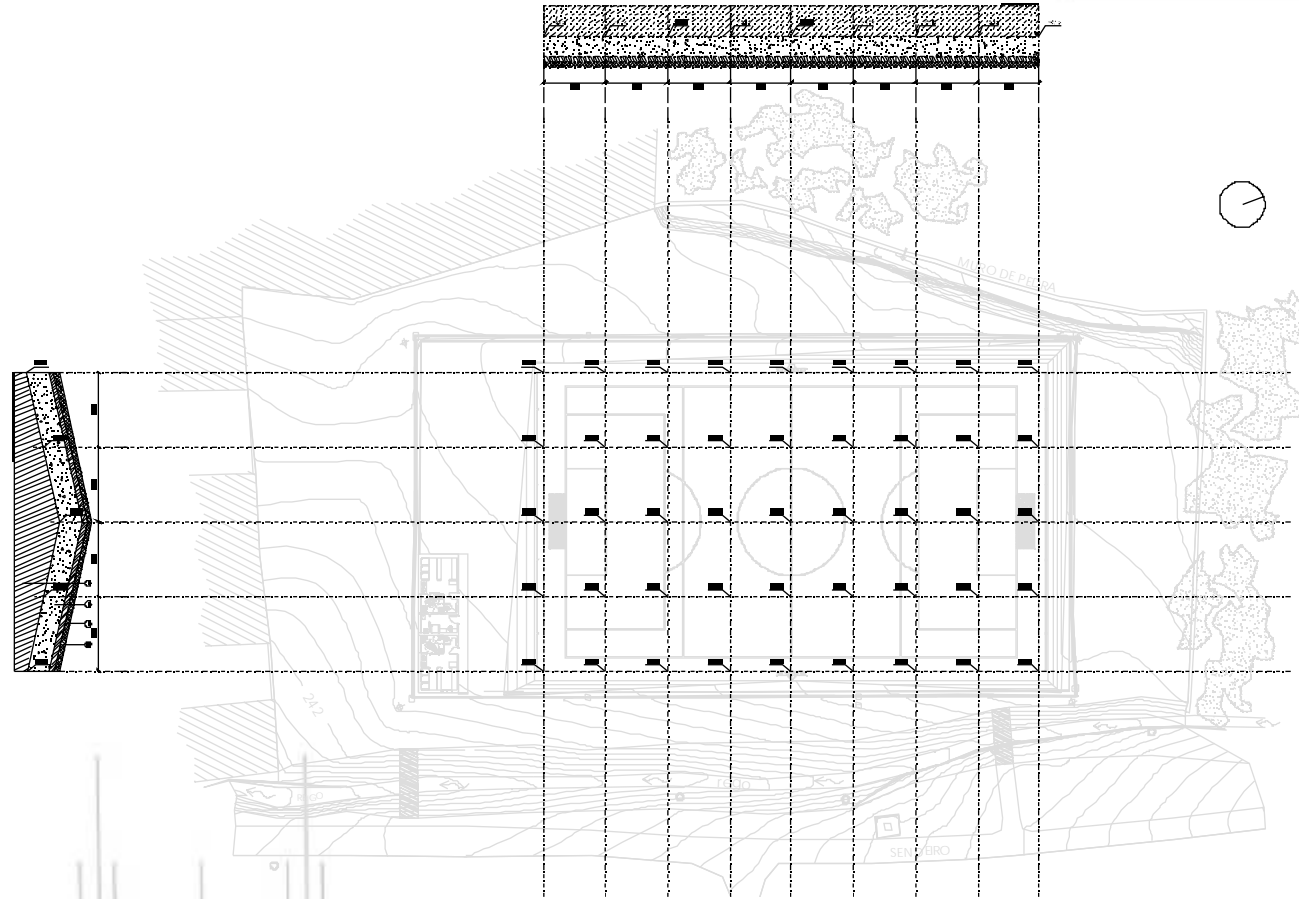

NIVELADO Y RASANTES
TERRENO DE JUEGO

CAMPO DE FUTBOL DE BELVIS

santiago de compostela

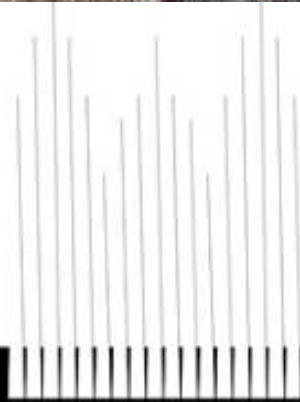
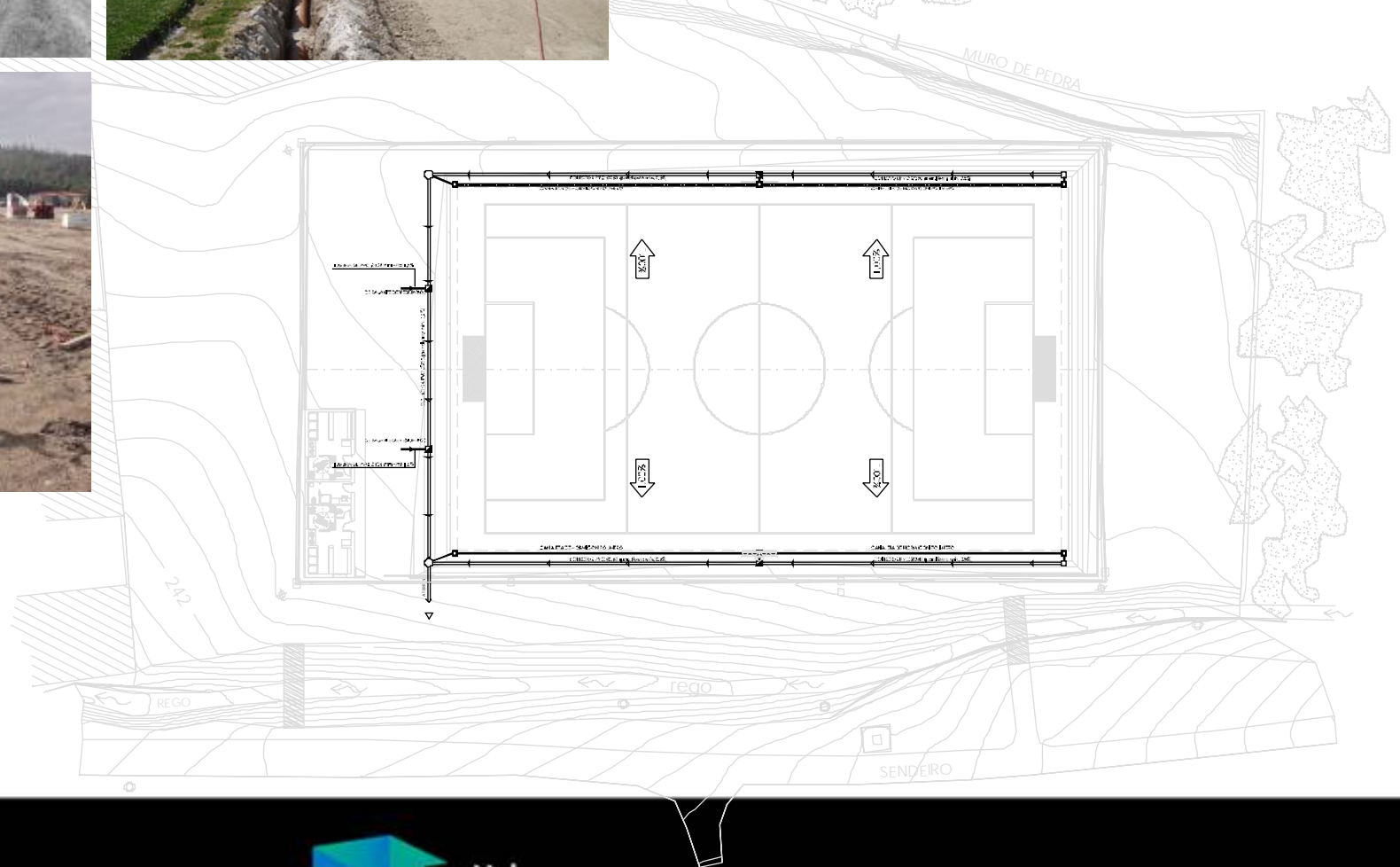
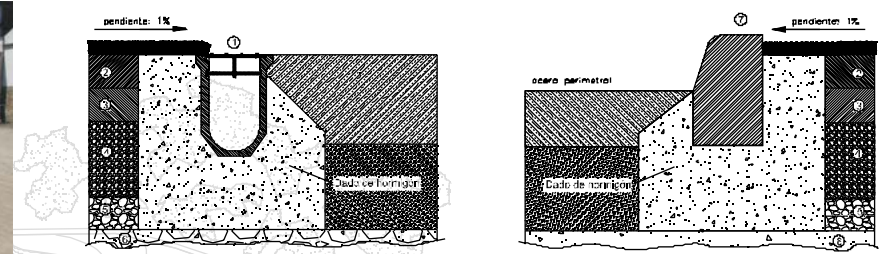

CONCELLO
DE
SANTIAGO



Urbana
Santiago
Norte

TALIESEN ARQUITECTOS, S.L.P.
ARQUITECTURA Y URBANISMO

CAMPO DE FUTBOL DE BELVIS

santiago de compostela



DESPIECE CESPED CAMPO

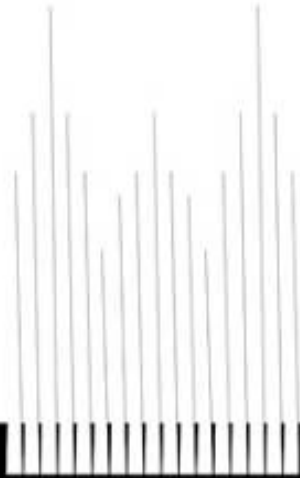
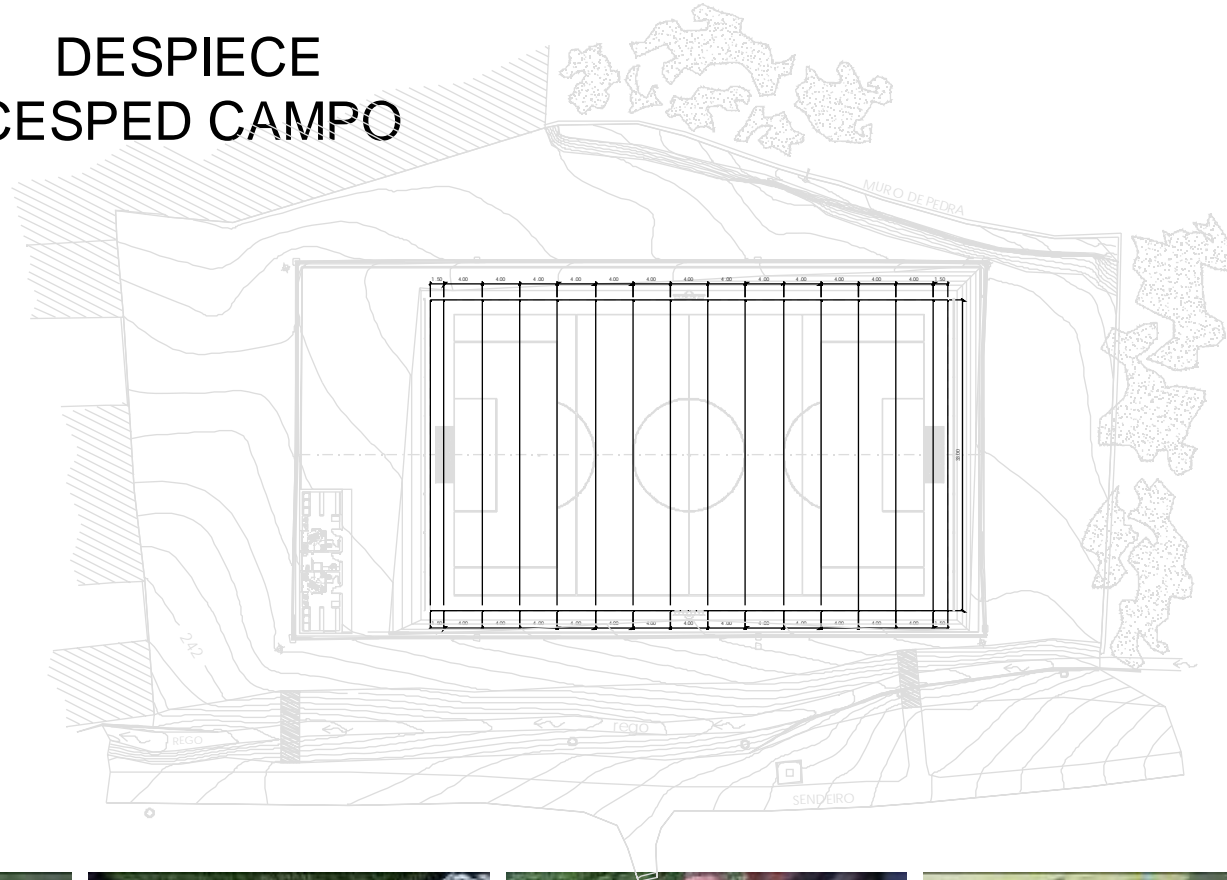

CONCELLO
DE
SANTIAGO



TALIESEN ARQUITECTOS, S.L.P.
ARQUITECTURA Y URBANISMO

CAMPO DE FUTBOL DE BELVIS

santiago de compostela

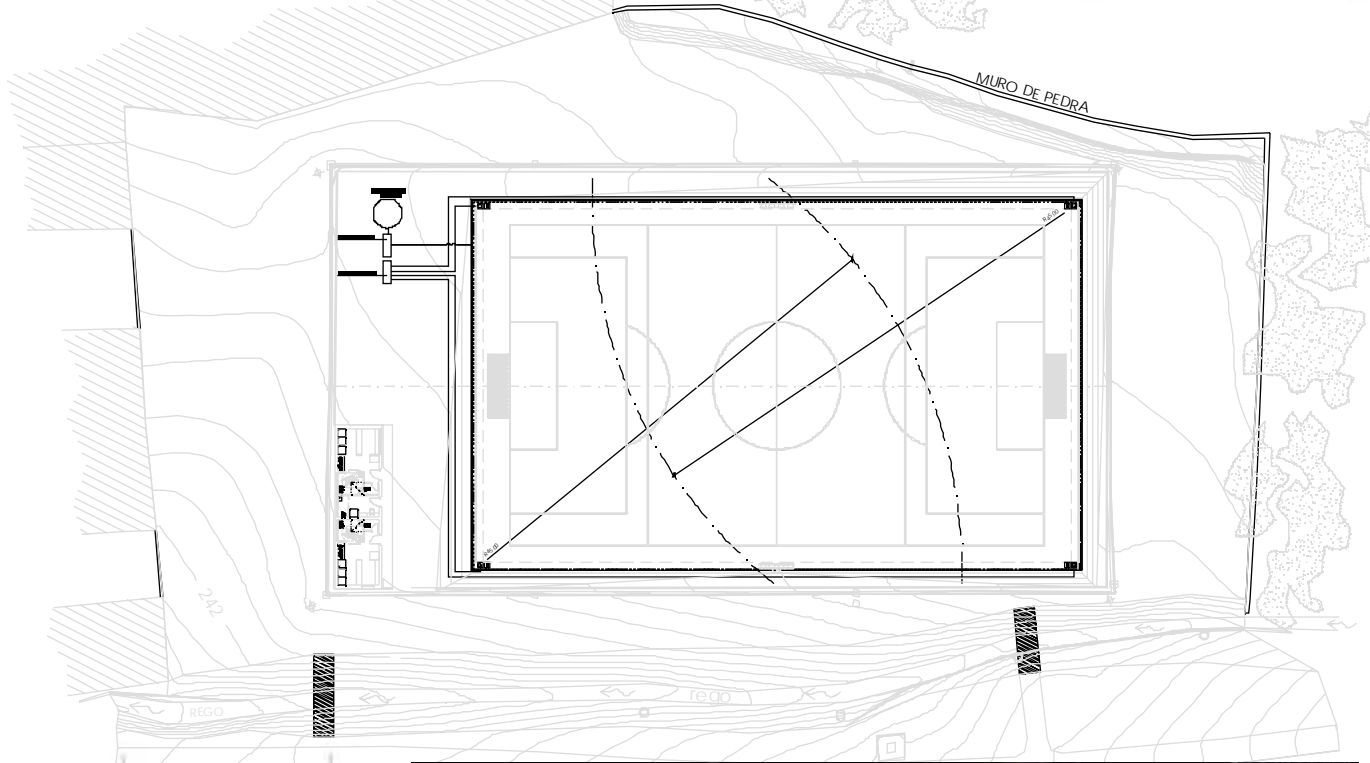

CONCELLO
DE
SANTIAGO



Urbana
Santiago
Norte

TALIESEN ARQUITECTOS, S.L.P.
ARQUITECTURA Y URBANISMO

CAMPO DE FUTBOL DE BELVIS

santiago de compostela

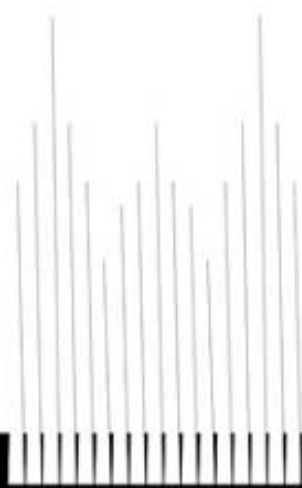
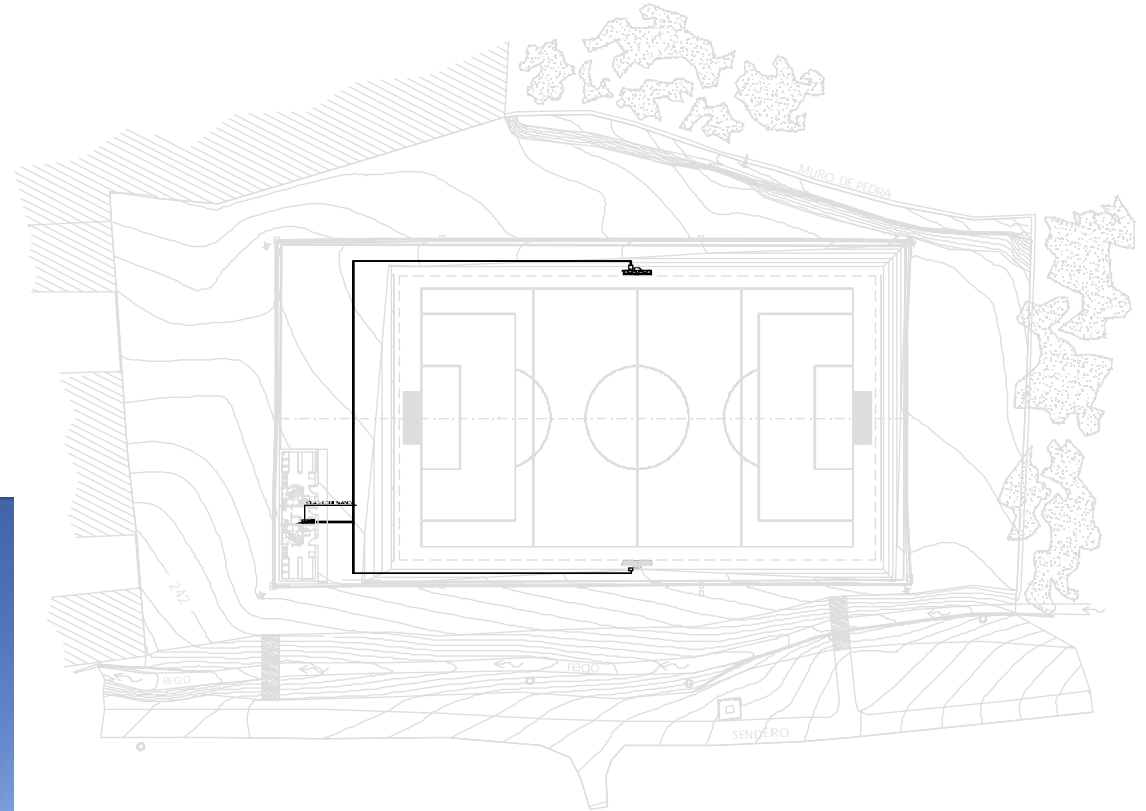
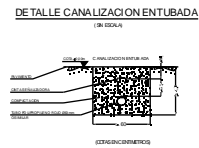
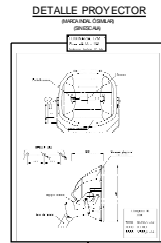
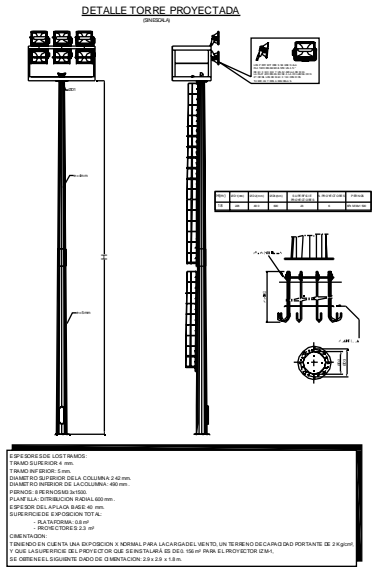

CONCELLO
DE
SANTIAGO



Urbana
Santiago
Norte

TALIESEN ARQUITECTOS, S.L.P.
ARQUITECTURA Y URBANISMO

CAMPO DE FUTBOL DE BELVIS

santiago de compostela



SUPERFICIES VESTUARIO 1

23.90 m²

SUPERFICIE VESTUARARIO 2

23.90 m²

SUPERFICIE VESTUARIO ARBITRO

7.80 m²

SUPERFICIE COSNTRUIDA

68.67 m²

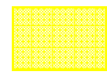
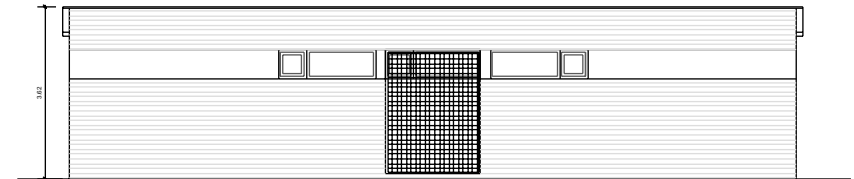
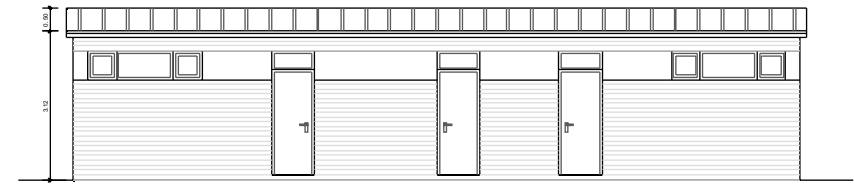

duchas

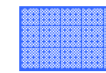

Vestuario
minusválido

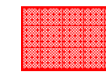

taquillas

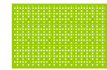

Lavabo y paso



inodoro



Lavabo e wc

VESTUARIOS

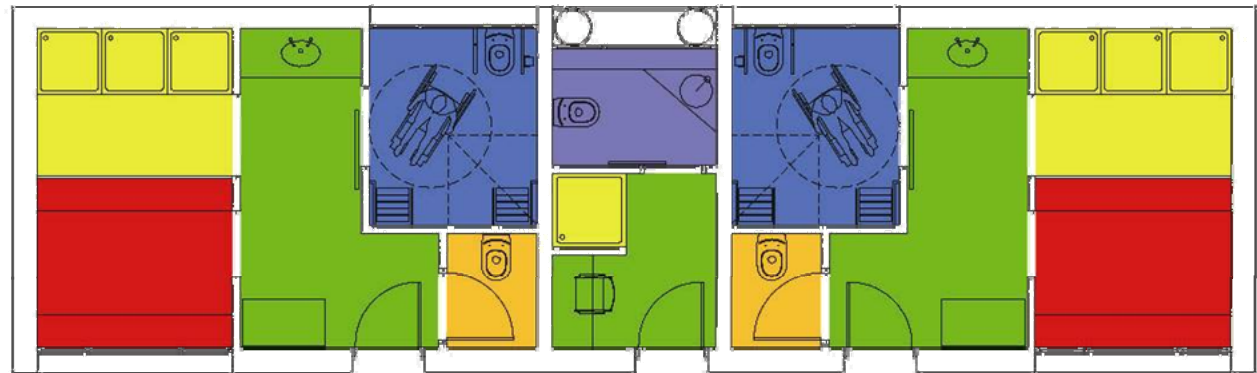

CONCELLO
DE
SANTIAGO



Urbana
Santiago
Norte

TALIESEN ARQUITECTOS, S.L.P.
ARQUITECTURA Y URBANISMO

CAMPO DE FUTBOL DE BELVIS

santiago de compostela

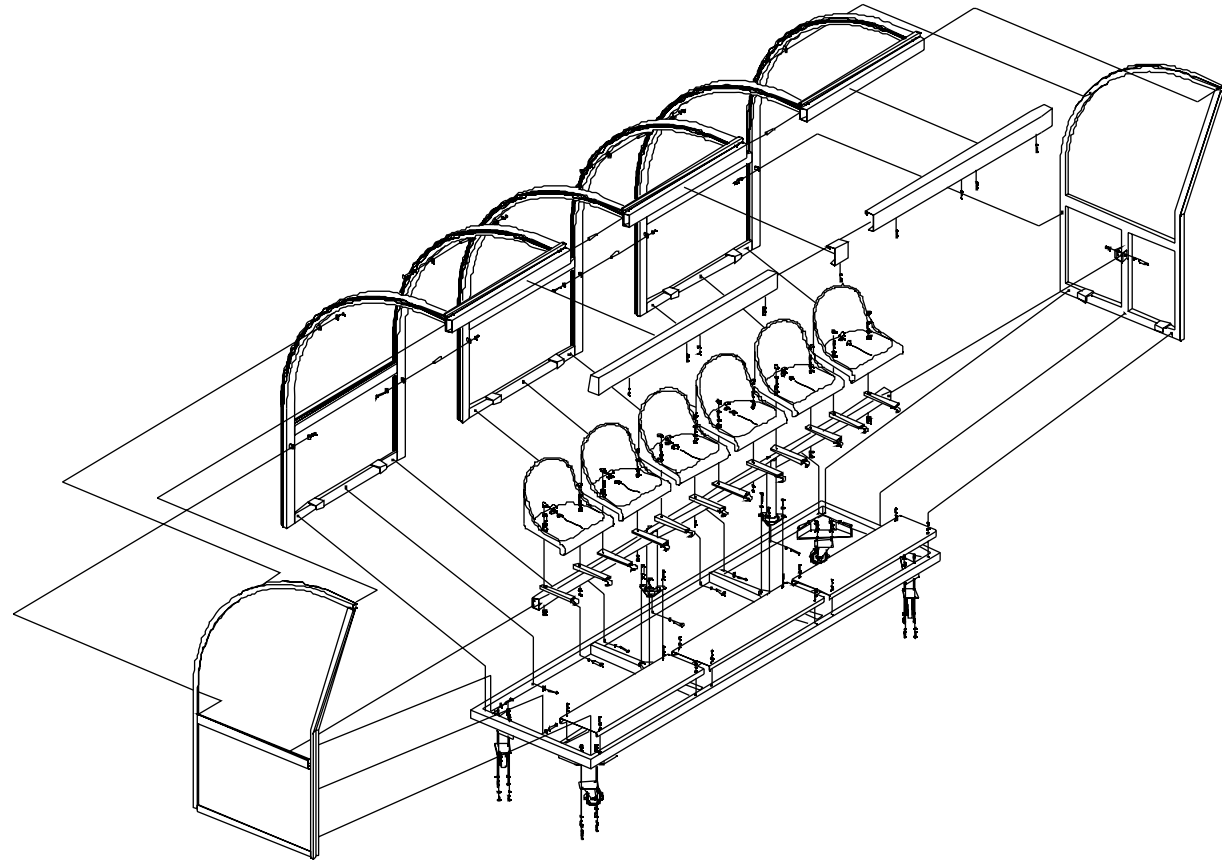

DETALLE BANQUILLO

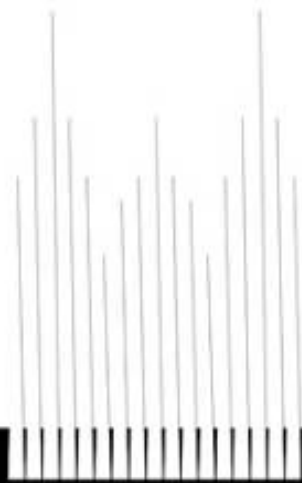

CONCELLO
DE
SANTIAGO



Urbana
Santiago
Norte

TALIESEN ARQUITECTOS, S.L.P.
ARQUITECTURA Y URBANISMO

CAMPO DE FUTBOL DE BELVIS

santiago de compostela

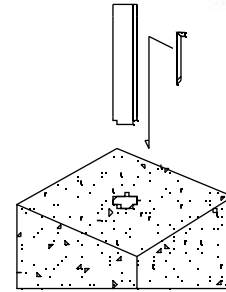
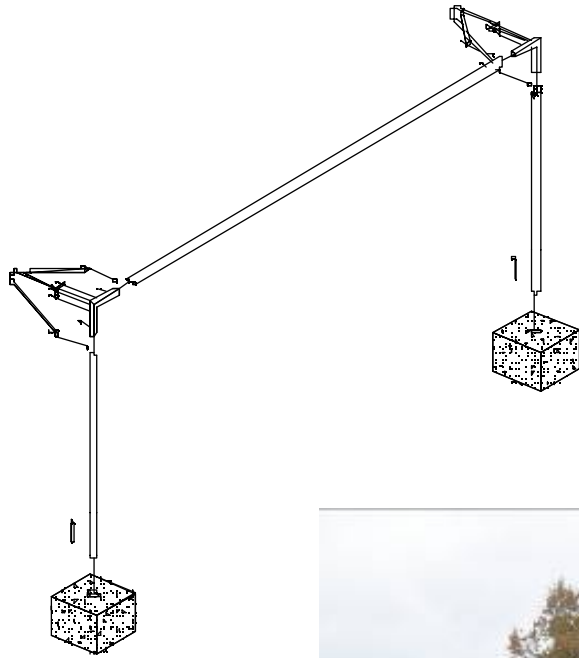

DETALLE ANCLAJE DE POSTE
A ZAPATA DE HORMIGÓN CON GUÍA

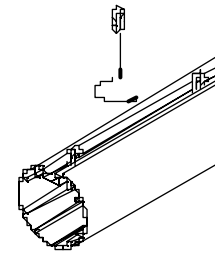

DETALLE ENGANCHE DE RED

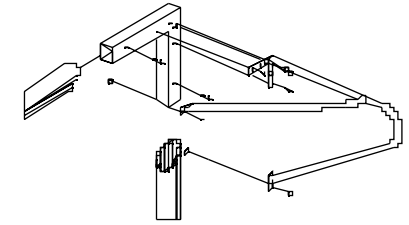

DETALLE UNIÓN POSTE-LARGUERO
Y ARQUILLO RED.

DETALLE PORTERIA

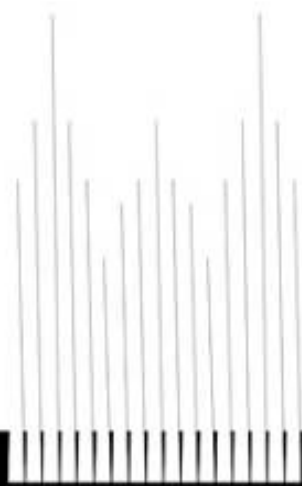

CONCELLO
DE
SANTIAGO



Urbana
Santiago
Norte

TALIESEN ARQUITECTOS, S.L.P.
ARQUITECTURA Y URBANISMO

CAMPO DE FUTBOL DE BELVIS

santiago de compostela



FOTOS ESTADO INICIAL

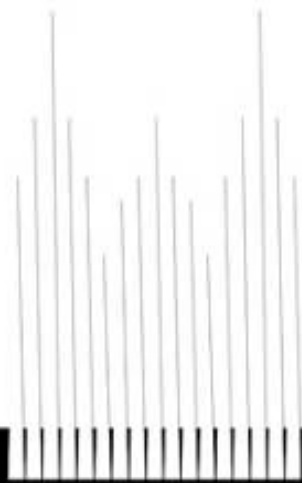

CONCELLO
DE
SANTIAGO



Urbana
Santiago
Norte

TALIESEN ARQUITECTOS, S.L.P.
ARQUITECTURA Y URBANISMO

CAMPO DE FUTBOL DE BELVIS

santiago de compostela

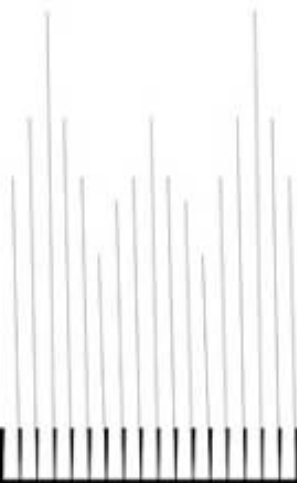

CONCELLO
DE
SANTIAGO



Urbana
Santiago
Norte

TALIESEN ARQUITECTOS, S.L.P.
ARQUITECTURA Y URBANISMO

CAMPO DE FUTBOL DE BELVIS

santiago de compostela

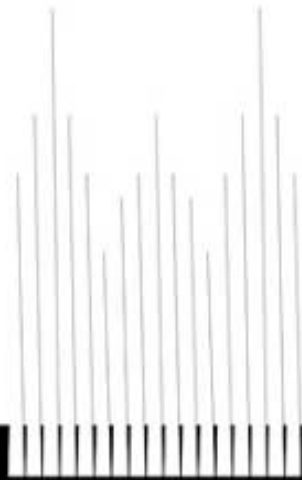

CONCELLO
DE
SANTIAGO



Urbana
Santiago
Norte

TALIESEN ARQUITECTOS, S.L.P.
ARQUITECTURA Y URBANISMO